

EFF-C / TFF-C

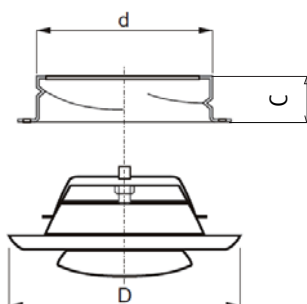

Rozměry



	ød	øD	C
EFF-C/TFF-C 80	78	106	50
EFF-C/TFF-C100	98	135	50
EFF-C/TFF-C 125	123	160	50
EFF-C/TFF-C 150	149	191	50
EFF-C/TFF-C 160	159	196	50
EFF-C/TFF-C 200	198	238	50

Popis

Kruhový odvodní/přívodní ventil EFF-C/TFF-C s nastavitelným středovým kuželem s možností fixace polohy pomocí kontramatice.

Specifikace objednávky

Ventil typ _____ EFF-C/TFF-C -125
 Průměr připojení _____

Funkce

EFF-C/TFF-C je kovový ventil pro montáž na stěnu a strop. Ventil má nastavitelný středový kužel, kterým je možné nastavit celkový tlak a tím i průtok vzduchu.

Konstrukce

EFF-C/TFF-C je vyroben z pozinkovaného ocelového plechu s práškovou barvou RAL 9010-80.

Montáž

Součástí ventilů TEFF-C/TFF-C je i zděř.

EFFC 080

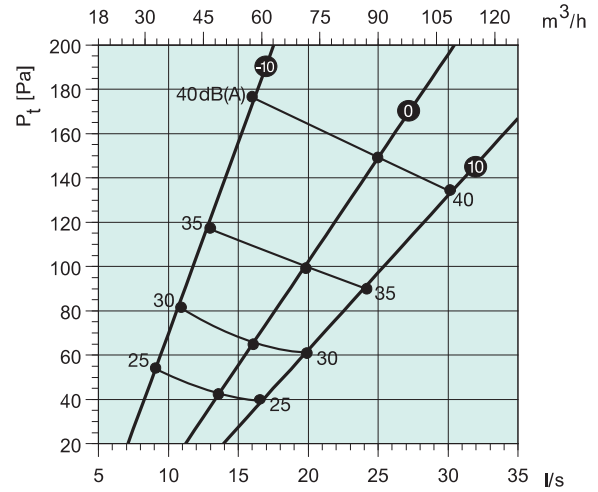

EFFC 100

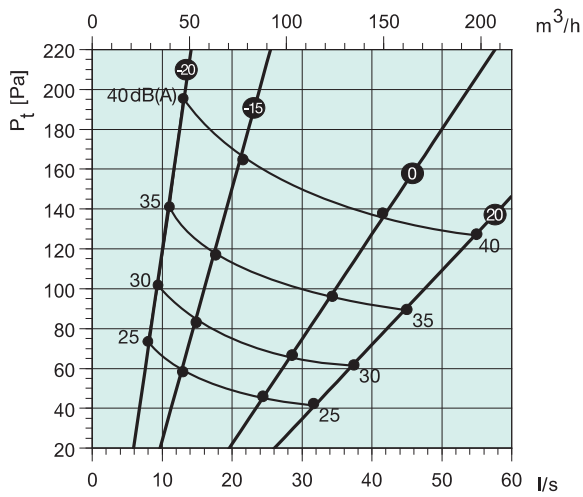

EFFC 125

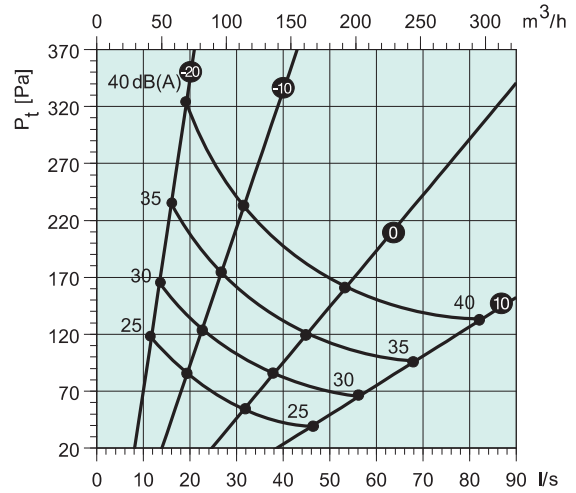

EFFC 150/160

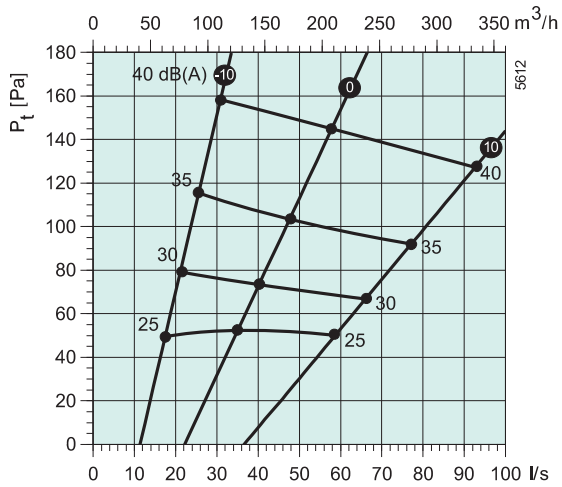

EFFC 200

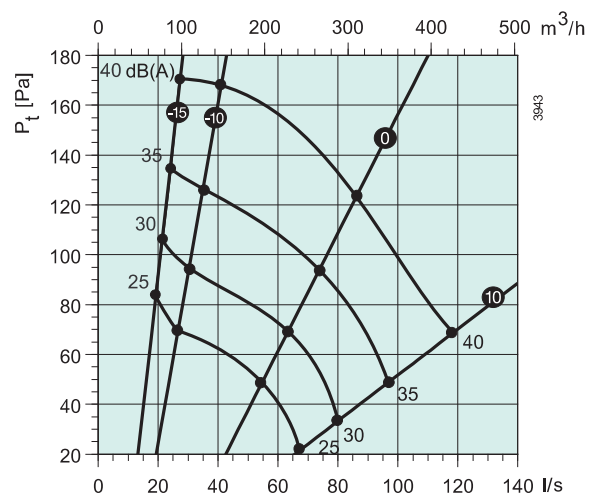

Přívodní difuzory

TFFC 080

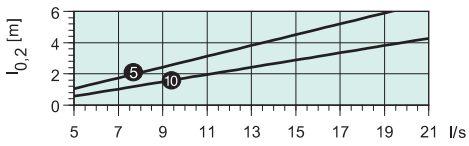
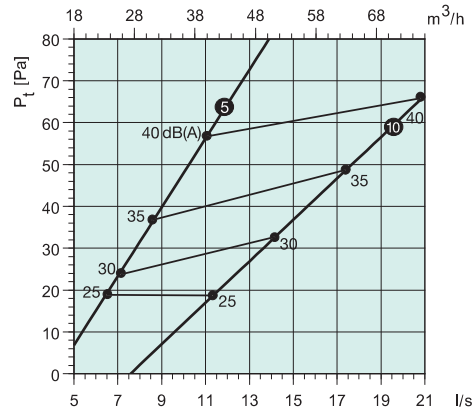

TFFC 100

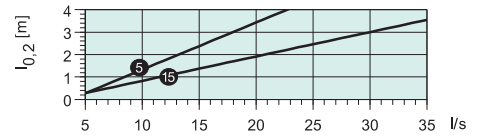
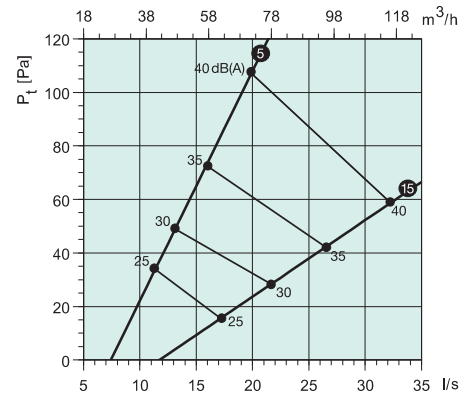

TFFC 125

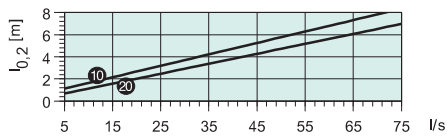
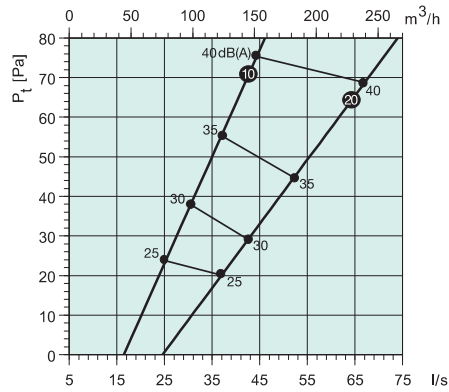

TFFC 150/160

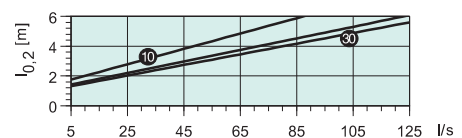
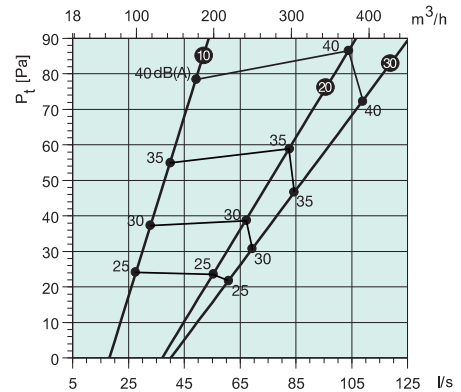

TFFC 200

